

"Molecular Photochemistry - how to study mechanisms of photochemical reactions ?"

Bronislaw Marciniak

Faculty of Chemistry, Adam Mickiewicz University,
Poznan, Poland

2014/2015 - lecture 1

Contents

1. Introduction and basic principles
(physical and chemical properties of molecules in the excited states, Jablonski diagram, time scale of physical and chemical events, definition of terms used in photochemistry).
2. Qualitative investigation of photoreaction mechanisms - steady-state and time resolved methods
(analysis of stable products and short-lived reactive intermediates, identification of the excited states responsible for photochemical reactions).
3. Quantitative methods
(quantum yields, rate constants, lifetimes, kinetic of quenching, experimental problems, e.g. inner filter effects).

Contents cont.

4. Laser flash photolysis in the study of photochemical reaction mechanisms ($10^{-3} - 10^{-12}$ s).
5. Examples illustrating the investigation of photoreaction mechanisms:
 - sensitized photooxidation of sulfur (II)-containing organic compounds,
 - photoinduced electron transfer and energy transfer processes,
 - sensitized photoreduction of 1,3-diketonates of Cu(II),
 - photochemistry of 1,3,5,-trithianes in solution.

Literature

1. „*Metody badania mechanizmów reakcji fotochemicznych*”, (*How to study mechanisms of photochemical reactions*) (in Polish), editor B. Marciniak, Wydawnictwo Naukowe UAM, Poznań 1999.
2. N.J. Turro, *Modern Molecular Photochemistry*, Benjamin/Cummings, Menlo Park, 1978; N.J. Turro, V. Ramamurthy, J.C. Scaiano, *Modern Molecular Photochemistry of Organic Molecules*, University Science Book, Sausalito/California, 2010.
3. J.A. Barltrop, J.D. Coyle, *Excited States in Organic Chemistry*, Wiley, New York, 1978.
4. G.J. Kavarnos, „*Fundamentals of Photoinduced Elektron Transfer*”, VCH, New York 1993.
5. B. Marciniak, *J. Chem. Education*, **63**, 998 (1986)
"Does Cu(acac)₂ Quench Benzene Fluorescence".
6. B. Marciniak, *J. Chem. Education*, **65**, 832 (1988)
"Photochemistry of Phenylalkyl Ketones. The "Norrish Type II" Photoreaction".
7. B. Marciniak, G.E. Buono-Core, *J. Photochem. Photobiol. A.: Chemistry*, **52**, 1 (1990)
"Photochemical Properties of 1,3-Diketonate Transition Metal Chelates".

Literature cont.

8. B. Marciniak, G.L. Hug, *Coord. Chem. Rev.*, **159**, 55 (1997)
"Quenching of Triplet States of Organic Compounds by 1,3-Diketonate Transition-Metal Chelates in Solution. Energy and/or Electron Transfer".
9. K. Bobrowski, B. Marciniak, G.L. Hug, *J. Am. Chem. Soc.*, **114**, 10279 (1992)
"4-Carboxybenzophenone Sensitized Photooxidation of Sulfur-Containing Amino Acids. Nanosecond Laser Flash Photolysis and Pulse Radiolysis Studies".
11. B. Marciniak, G.L. Hug, J. Rozwadowski, K. Bobrowski, *J. Am. Chem. Soc.*, **117**, 127 (1995)
"Excited Triplet State of N-(9-methylpurin-6-yl)pyridinium Cation as an Efficient Photosensitizer in the Oxidation of Sulfur-Containing Amino Acids. Laser Flash and Steady-State Photolysis Studies".
12. E. Janeba-Bartoszewicz, G.L. Hug, E. Andrzejewska, B. Marciniak, *J. Photochem. Photobiol. A: Chemistry*, **177**, 17-23 (2006)
"Photochemistry of 1,3,5-trithianes in solution. Steady-state and laser flash photolysis studies".

Textbooks on photochemistry

1. N.J. Turro, *Modern Molecular Photochemistry*, Benjamin/Cummings, Menlo Park, 1978.
2. A. Barltrop, J.D. Coyle, *Excited States in Organic Chemistry*, Wiley, New York, 1978.
3. A. Gilbert, J. Baggott, *Essentials of Molecular Photochemistry*, Blackwell Scientific Publications, Oxford, 1991.
4. R.P. Wayne, *Principles and Applications of Photochemistry*, Oxford University Press, 1988.
5. J.F. Rabek, *Experimental Methods in Photochemistry and Photophysics*, volumes 1 i 2, Wiley, New York, 1982
6. S.L. Murov, J. Carmichael, G.L. Hug, *Handbook of Photochemistry*, Marcel Dekker, New York, 1993.
7. M. Montalti, A. Credi, L. Prodi, M.T. Gandolfi, *Handbook of Photochemistry*, CRC Press, Boca Raton, 2006.

Textbooks on photochemistry

Organic photochemistry:

1. J.A. Barltrop, J.D. Coyle, *Excited States in Organic Photochemistry*, Wiley, New York, 1978.
2. M. Klessinger, J. Michl, *Excited States and Organic Photochemistry*, VCH, 1995.
3. J. Kagan, *Organic Photochemistry. Principles and Applications*, Academic Press, London, 1993.
4. J. Kopecky, *Organic Photochemistry. A Visual Approach*, VCH, New York, 1992.
5. J. Michl, V. Bonacic-Kouteck, *Electronic Aspects of Organic Photochemistry*, Wiley, New York, 1990.
6. *Handbook of Organic Photochemistry*, Ed. J.C. Scaiano, CRL Press, Boca Raton, tomy 1 i 2, 1989.
7. *CRC Handbook of Organic Photochemistry*, Ed. W.M. Horspool, CRC Press, Boca Raton, 1995.
8. *Synthetic Organic Photochemistry*, Ed. W.M. Horspool, Plenum Press, New York, 1984.

Textbooks on photochemistry

Inorganic photochemistry:

1. V. Balzani, V. Carassiti, *Photochemistry of Coordination Compounds*, Academic Press, London, 1970.
2. *Concepts of Inorganic Photochemistry*, pod red. A.W. Adamson i P.D. Fleischauer, Wiley, New York, 1975.
3. G.J. Ferraudi, *Elements of Inorganic Photochemistry*, Wiley, New York, 1988.

Others:

1. V. Balzani, F. Scandola, *Supramolecular Photochemistry*, Ellis Horwood, New York, 1991.
2. G.J. Kavarnos, *Fundamentals of Photoinduced Electron Transfer*, VCH, New York, 1993.
3. *Photoinduced Electron Transfer*, pod red. M.A. Fox i M. Chanon, tomy 1-4, Elsevier, Amsterdam, 1988.
4. J.B. Birks, *Photophysics of Aromatic Molecules*, Wiley, New York, 1970.
5. *Glossary of Terms Used in Photochemistry*, Pure Applied Chemistry **79**, 293–465 (2007)
6. J.E. Guillet, *Polymer Photophysics and Photochemistry*, Cambridge University Press, Cambridge, 1985

1. Introduction and basic principles

- physical and chemical properties of molecules in the excited states,
- Jablonski diagram,
- time scale of physical and chemical events,
- definition of terms used in photochemistry

Energy level diagram

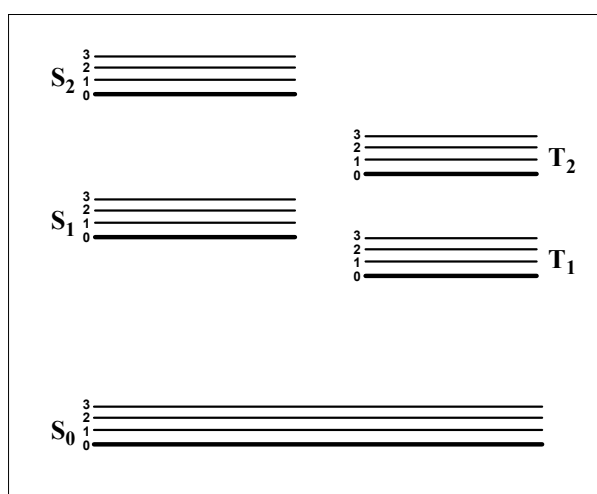

Physical and chemical properties of molecules in the excited states (comparison with the ground state)

1. Energy (80 – 400 kJ/mol)
2. Lifetimes (10^{-12} – 10^0 s)
3. Geometry of excited molecules (bond lengths, angles)
4. Dipole moments (redistributions of electron densities)
5. Chemical properties (photochemical reactions)

Table 1. Energies and lifetimes for lowest excited states (S_1 i T_1) organic molecules in solutions

Compound	E_S (kJ/mol)	τ_S (ns)	E_T (kJ/mol)	τ_T (μ s)
Benzene ^{a)}	459	34	353	–
Naphtalene ^{a)}	385	96	253	175
Antracene ^{a)}	318	5.3	178	670
Tetracene ^{a)}	254	6.4	123	400
Benzophenone ^{b)}	316	0.03	287	6.9
C_{60} ^{a)}	193	1.2	151	250

^{a)} in nonpolar solvents, ^{b)} in benzene

Tabela 2. Dipole moments of organic molecules in the ground state (S_0) and in the lowest excited singlet states (S_1)

Compound	Dipole moment (in Debyes)	
	S_0	S_1
Formaldehyde	2.3	1.6
Benzophenone	3.0	1.2
p-Nitroaniline	6	14
4-Amino-4'-nitrobiphenyl	6	16

Tabela 3. pK_a values in the ground and lowest excited S_1 and T_1 states for organic compounds

Compound	pK _a (S_0)	pK _a [*] (S_1)	pK _a [*] (T_1)
1-Naphtol	9.2	2,0	–
2-Naphtol	9.5	2,8–3,1	7,7–8,1
1-Naphtoic acid	3.7	10–12	3,8–4,6
Acridine cation	5.5	10,6	5,6
2-Naphtylamine cation	4.1	–2	3,1–3,3

Acid -base properties in the excited states

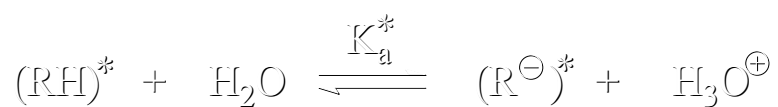
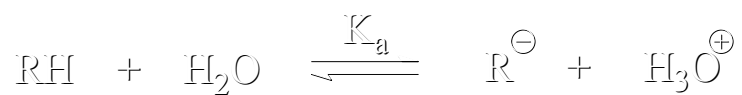

Photochemical reactions:



- Photodissociation
(photofragmentation)
- Photocycloaddition
- Photoisomerization
- Photorearrangements
- Photo addition
- Photosubstitution
- Photooxidation
- Photoreduction
- other Photo....

Intermolecular Excited-State Reactions

- Energy Transfer

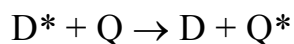

- Electron Transfer

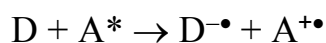
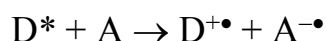

Note:

Have to have excited states that live long enough to find quenching partner by diffusion

- Hydrogen Abstractions

Physical and chemical properties of molecules in the excited states

1. Energy (80 – 400 kJ/mol)
2. Lifetimes (10^{-12} – 10^0 s)
3. Geometry of excited molecules
(bond lengths, angles)
4. Dipole moments (redistributions of electron densities)
5. Chemical properties (photochemical reactions)

Conclusion: Molecules in the excited states are characterized by different physical and chemical properties in comparison with those in the ground states.

They act like distinct chemical species.

Scheme of photochemical reaction

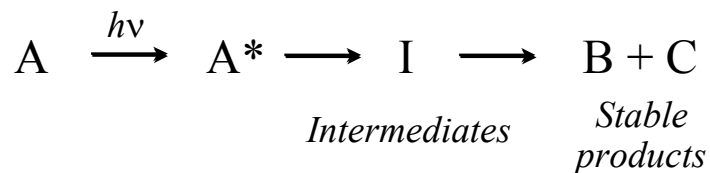

Reactive Intermediates

- Want to see time development of excited states and free radicals
- Excited states and free radicals act as individual chemical species during their existence.
- They are species of particular interest because of their high energy content.
- If you can capture their energy content, you can do chemistry that you cannot do in ground states.

How to Utilize the Energy Content?

- If excited states channel their energy into specific bonds, then photochemistry can occur.
- If scavengers or quenchers can find the excited state or free radical in time, then the electronic or chemical energy can be captured by the, ordinarily, stable scavenger or quencher.

Jablonski diagram

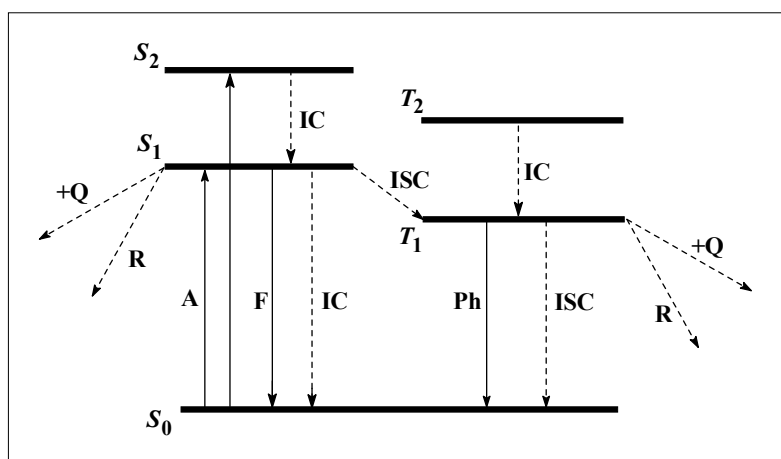

Alexander Jabłoński (1898–1980)

before 1939 University of Warsaw, Institute of Experimental
Physics

1943–1945 Edinburgh Medical School

1946–1980 Copernicus University in Toruń

about 70 scientific papers on atomic and molecular spectroscopy

A. Jabłoński
Nature 1933, 839

Efficiency of Anti-Stokes Fluorescence in Dyes

ACCORDING to Kautsky and his collaborators¹, the majority of the molecules of dyes investigated by them, among which were also the molecules of fluoresceine, show an ability to phosphoresce when 'energetically isolated', for example, when adsorbed by convenient adsorbents. We can assume therefore

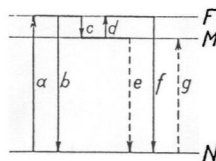
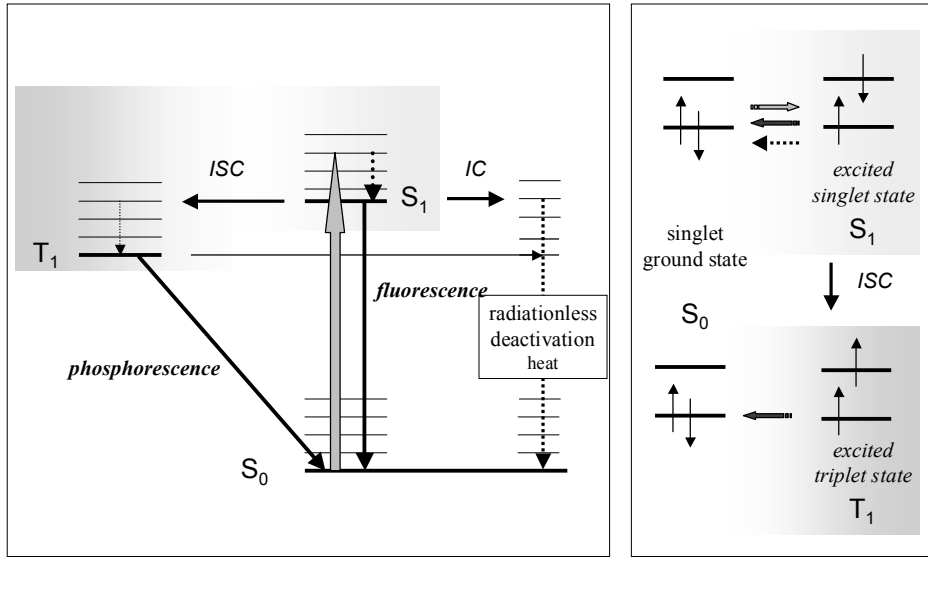

FIG. 1.—Energy levels in a phosphorescent molecule. *a*—absorption, *b*—fluorescence, *c*—transition to metastable level, *d*—thermal excitation, *e* and *f*—phosphorescence, *g*—absorption of very small transition probability.

that in such molecules there must be at least one metastable energy level *M* (Fig. 1), situated lower than the level *F* reached immediately after absorption. From the state *F* the molecules can pass either to a normal state *N*, emitting the band *F*–*N* (fluorescence), or to the metastable state *M*. The probability of the transition *M*–*N* is very small. Therefore when the temperature is sufficiently high, a great majority of molecules will be raised thermally from the level *M* to *F* and will be able to emit the band *F*–*N* (phosphorescence at room temperature). At low temperatures, direct transitions *M*–*N* take place. These transitions are accompanied by the emission of a phosphorescence band which is displaced towards the red relatively to band *F*–*N*; the duration of phosphorescence increases greatly (phosphorescence at low temperatures).

Jablonski - diagram



Radiationless Transitions Showing Nuclear Contributions

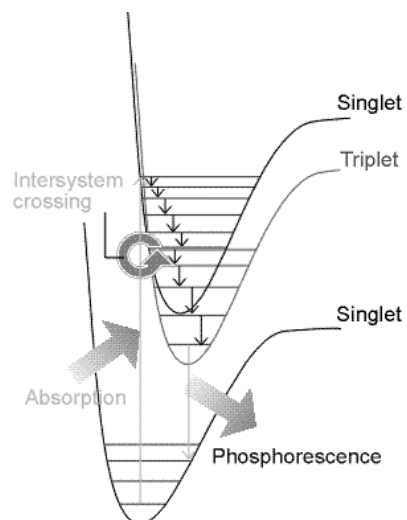

“Stokes” shift
Absorption vs Emission

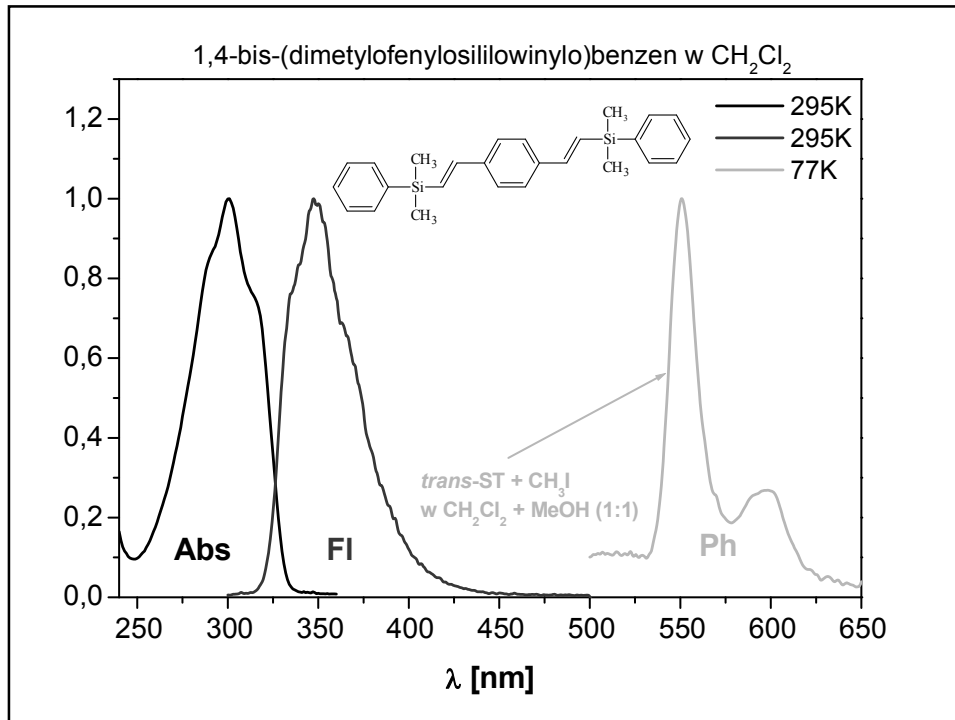
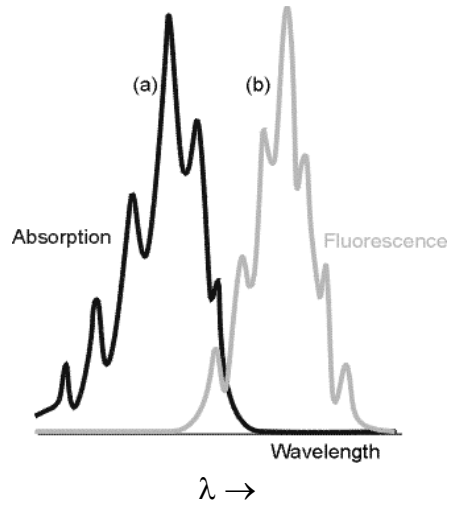

Kasha's rule

In most of photochemical reactions of organic compounds only the lowest excited states (S_1 and T_1) are reactive states
(rapid radiationless conversion to S_1 or T_1)

Exceptions: emission from S_2 excited singlets for azulene, thioketones

Energy Gap Law

- The rate of radiationless transitions goes as the exponential of the energy gap between the 0-0 vibronic levels of the two electronically excited states.

„the smaller the energy gap the bigger the rate”

Processes from S_1 state:

- fluorescence (F)
- internal conversion (IC)
- intersystem crossing (ISC) $S_1 \rightarrow T_1$
- chemical reaction (R_S)
- quenching (+Q):

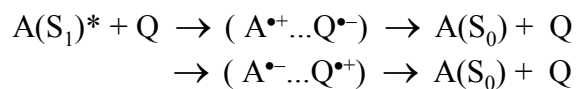
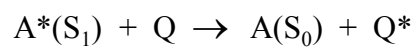

Processes from T_1 state:

- phosphorescence (P)
- intersystem crossing (ISC) $T_1 \rightarrow S_0$
- chemical reaction (R_T)
- quenching (+Q)

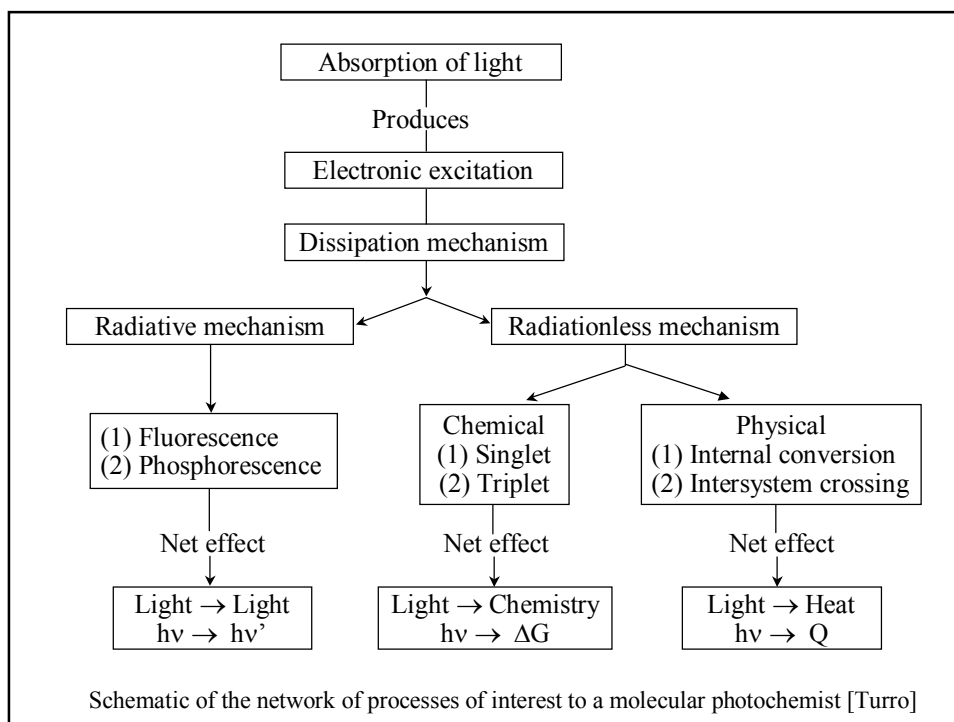

Comparison of time scales of physical and chemical events of photochemical interest (10^{-15} s - 1s) [Turro]

	time scale (s)	
	<i>femto</i>	
	— 10^{-15}	electronic motion
	<i>pico</i>	
	— 10^{-12}	vibrational motion bond cleavage (weak)
Fluorescence	<i>nano</i>	
	— 10^{-9}	rotational and translational motion (small molecules fluid)
	<i>micro</i>	
	— 10^{-6}	rotational and translational motion (large molecules fluid) ultrafast chemical reaction
Phosphorescence	<i>milli</i>	
	— 10^{-3}	rotational and translational motion (large molecules, very viscous)
	— 10^0	fast chemical reactions

Definition of terms used in photochemistry

2007 IUPAC, S. E. Braslavsky, *Pure and Applied Chemistry* **79**, 293–465

Lifetimes:

Lifetime of a molecular entity, which decays by first-order kinetics, is the time needed for a concentration of the entity to decrease to $1/e$ of its original value, i.e., $c(t=\tau) = c(t=0)/e$.

It is equal to the reciprocal of the sum of the first-order rate constants of all processes causing the decay of the molecular entity.

$$\tau_S = \frac{1}{\sum_i k_i^S} = \frac{1}{k_f + k_{IC} + k_{ISC} + k_r + k_q[Q]}$$
$$\tau_T = \frac{1}{\sum_i k_i^T} = \frac{1}{k_p + k'_{ISC} + k'_r + k'_q[Q]}$$

Definition of terms used in photochemistry

2007 IUPAC, S. E. Braslavsky, *Pure and Applied Chemistry* **79**, 293–465

Lifetimes:

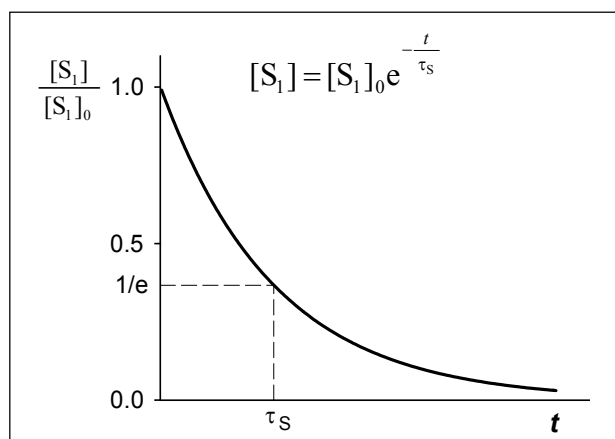

Definition of terms used in photochemistry

2007 IUPAC, S. E. Braslavsky, *Pure and Applied Chemistry* **79**, 293–465

Quantum yields Φ :

Number of defined events occurring per *photon* absorbed by the system.

Integral quantum yield:

$$\Phi = \frac{\text{number of events}}{\text{number of photons absorbed}}$$

For a photochemical reaction $A \xrightarrow{h\nu} B$:

$$\Phi_R = \frac{\text{amount of reactant consumed or product formed}}{\text{amount of photons absorbed}}$$

Definition of terms used in photochemistry

2007 IUPAC, S. E. Braslavsky, *Pure and Applied Chemistry* **79**, 293–465

For a photochemical reaction $A \xrightarrow{h\nu} B$:

Integral quantum yield:

$$\Phi_A = \frac{[A]_t - [A]_0}{\int_0^t I_a dt} \quad \Phi_B = \frac{[B]_t}{\int_0^t I_a dt}$$

Differential quantum yield:

$$\Phi_A = -\frac{d[A]}{I_a dt} \quad \Phi_B = \frac{d[B]}{I_a dt}$$

Experimental parameters characterizing fluorescence properties of molecules

$$1. \quad k_f = \frac{1}{\tau_0^f} \qquad k_f \sim \nu_0^2 \int \epsilon \, d\nu$$

τ_0^f is radiative lifetime (Einstein coefficient of spontaneous emission)

$$2. \quad \Phi_f \qquad \Phi_f = \frac{k_f}{\sum_i k_i^S} = k_f \tau_S$$

$$3. \quad \tau_S \qquad \tau_S = \frac{1}{\sum_i k_i^S}$$

Some examples of fluorescence quantum yields and other emission parameters [Turro]

Compound	Φ_F	ϵ_{\max}	k_f (s ⁻¹)	k_{ISC} (s ⁻¹)	Configuration of S ₁
Benzene	~0.2	250	2×10 ⁶	10 ⁷	π, π*
Naphthalene	~0.2	270	2×10 ⁶	5×10 ⁶	π, π*
Anthracene	~0.4	8500	5×10 ⁷	~5×10 ⁷	π, π*
9,10-Diphenylanthracene	~1.0	12600	~5×10 ⁸	<10 ⁷	π, π*
Pyrene	~0.7	510	~10 ⁶	<10 ⁵	π, π*
Triphenylene	~0.1	355	~2×10 ⁸	~10 ⁷	π, π*
Perylene	~1.0	39500	~10 ⁸	<10 ⁷	π, π*
Stilbene	~0.05	24000	~10 ⁸	~10 ⁹	π, π*
1-Chloronaphthalene	~0.05	~300	~10 ⁶	5×10 ⁸	π, π*
1-Bromonaphthalene	~0.002	~300	~10 ⁶	~10 ⁹	π, π*
1-Iodonaphthalene	~0.000	~300	~10 ⁶	~10 ¹⁰	π, π*
Benzophenone	~0.000	~200	~10 ⁶	~10 ¹¹	n, π*
Acetone	~0.001	~20	~10 ⁵	~10 ⁹	n, π*
Perfluoroacetone	~0.1	~20	~10 ⁵	~10 ⁷	n, π*

Experimental parameters characterizing phosphorescence properties of molecules

1. $k_p = \frac{1}{\tau_0^p}$

2. $\Phi_{ISC}(S_1 \rightarrow T_1)$

3. Φ_p

4. τ_T

$$k_p \sim \nu_0^2 \int \epsilon_{S \rightarrow T} d\bar{\nu}$$

$$\Phi_{ISC} = k_{ISC} \tau_S$$

$$\Phi_p = \Phi_{ISC} \frac{k_p}{\sum_i k_i^T} = \Phi_{ISC} k_p \tau_T$$

$$\tau_T = \frac{1}{\sum_i k_i^T}$$

Quantum yields for phosphorescence and other triplet emission parameters [Turro]

Compound	Φ_p		Φ_{ISC}	k_p (s ⁻¹)	Configuration of T ₁
	77K	25°C			
Benzene	~0.2	(<10 ⁻⁴)	~0.7	~10 ⁻¹	π, π^*
Naphthalene	~0.05	(<10 ⁻⁴)	~0.7	~10 ⁻¹	π, π^*
1-Fluoronaphthalene	~0.05	(<10 ⁻⁴)	—	~0.3	π, π^*
1-Chloronaphthalene	~0.3	(<10 ⁻⁴)	~1.0	~2	π, π^*
1-Bromonaphthalene	~0.3	(<10 ⁻⁴)	~1.0	~30	π, π^*
1-Iodonaphthalene	~0.4	—	~1.0	~300	π, π^*
Triphenylene	~0.5	(<10 ⁻⁴)	~0.9	~10 ⁻¹	π, π^*
Benzophenone	~0.9	(~0.1)	~1.0	~10 ²	n, π^*
Biacetyl	~0.3	(~0.1)	~1.0	~10 ²	n, π^*
Acetone	~0.03	(~0.01)	~1.0	~10 ²	n, π^*
4-Phenylbenzophenone	—	—	~1.0	1.0	π, π^*
Acetophenone	~0.7	(~0.03)	~1.0	~10 ²	n, π^*
Cyclobutanone	0.0	0.0	0.0	—	n, π^*

Lifetimes & Quantum Yields

- Triplet states have much longer lifetimes than singlet states
- In solutions, singlets live on the order of nanoseconds or 10's of nanoseconds
- Triplets in solution live on the order of 10' or 100's of microseconds
- Triplets rarely phosphoresce in solution (competitive kinetics)

Important Types of Organic Excited States

- π, π^* states, particularly in aromatics and polyenes
- n, π^* states, particular in carbonyls

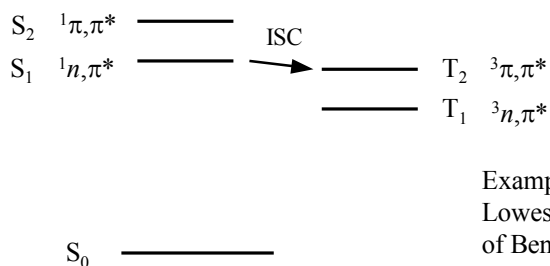

Example:
Lowest electronic states
of Benzophenone

Why Triplet Quantum Yield is high in Benzophenone?

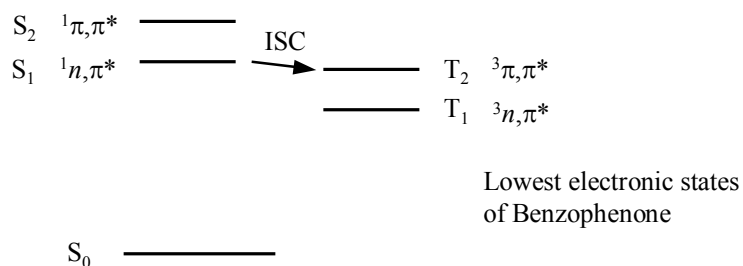

- (1) $^1n, \pi^*$ states have small k_{rad} because of small orbital overlap
- (2) k_{isc} is large because of low-lying $^3\pi, \pi^*$ and El-Sayed's Rule

Selection Rules for ISC

- El-Sayed's Rule:

Allowed: $^1(n, \pi^*) \leftrightarrow ^3(\pi, \pi^*)$; $^3(n, \pi^*) \leftrightarrow ^1(\pi, \pi^*)$

Forbidden: $^1(n, \pi^*) \leftrightarrow ^3(n, \pi^*)$; $^3(\pi, \pi^*) \leftrightarrow ^1(\pi, \pi^*)$

- Intersystem crossing between states of like orbital character is slower than ISC between states of different orbital character.

Characteristics of Radiationless Transitions

- Kasha's Rule
- El-Sayed's Rule
- Wavelength Independence of Luminescence
- Energy Gap Law
- Competitive First-Order Kinetics

Lambert-Beer law

$$-\frac{dI}{I} = k c d l$$

$$\log \frac{I_0}{I} = \epsilon c l$$

$$\boxed{A = \epsilon c l}$$



$$I = I_0 10^{-\epsilon c l}$$

$$\boxed{I_a = I_0 (1 - 10^{-\epsilon c l})}$$

$$A = \log \frac{I_0}{I}$$

$$T = \frac{I}{I_0}$$

$$A = \log \frac{1}{T}$$

Acid-base properties in the excited states

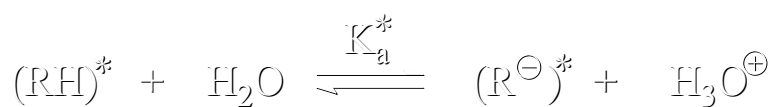
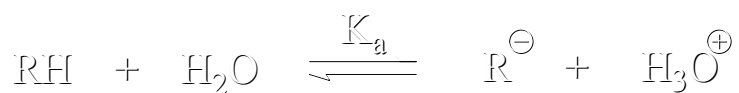

B. Marciniak, H. Kozubek, S. Paszyc
J. Chem. Education, **69**, 247-249 (1992)
 "Estimation of pK in the First Excited Singlet State"

Estimation of pK in the First Excited Singlet State

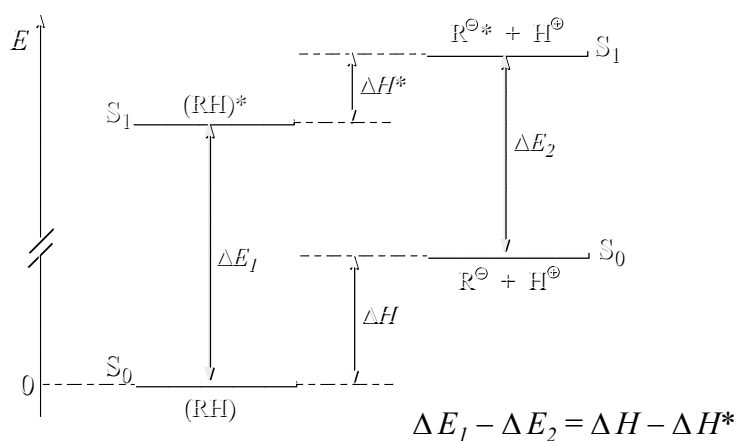

Thermodynamic Förster cycle

$$\Delta E_1 - \Delta E_2 = \Delta H - \Delta H^*$$

$$\Delta G = \Delta H - T\Delta S$$

$$\Delta E_1 - \Delta E_2 = (\Delta G + T\Delta S) - (\Delta G^* + T\Delta S^*)$$

$$\Delta G = -RT \ln K_a \quad \Delta S = \Delta S^*$$

$$\Delta G - \Delta G^* = -RT (\ln K_a - \ln K_a^*) = \Delta E_1 - \Delta E_2$$

$$\text{p}K_a - \text{p}K_a^* = \frac{\Delta E_1 - \Delta E_2}{2.303 RT}$$

$$\Delta E_1 = N_A hc \frac{\nu_1^{\text{abs}} + \nu_1^{\text{flr}}}{2}$$

$$\Delta E_2 = N_A hc \frac{\nu_2^{\text{abs}} + \nu_2^{\text{flr}}}{2}$$

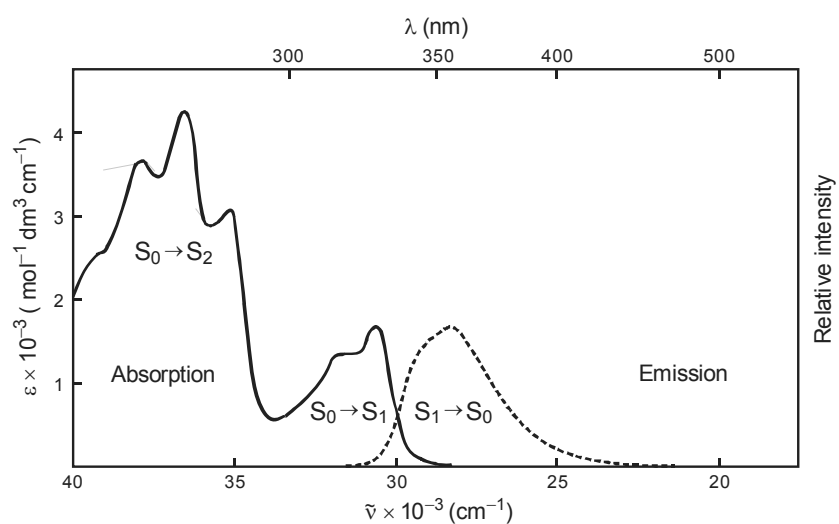

2-naphthol in HCl

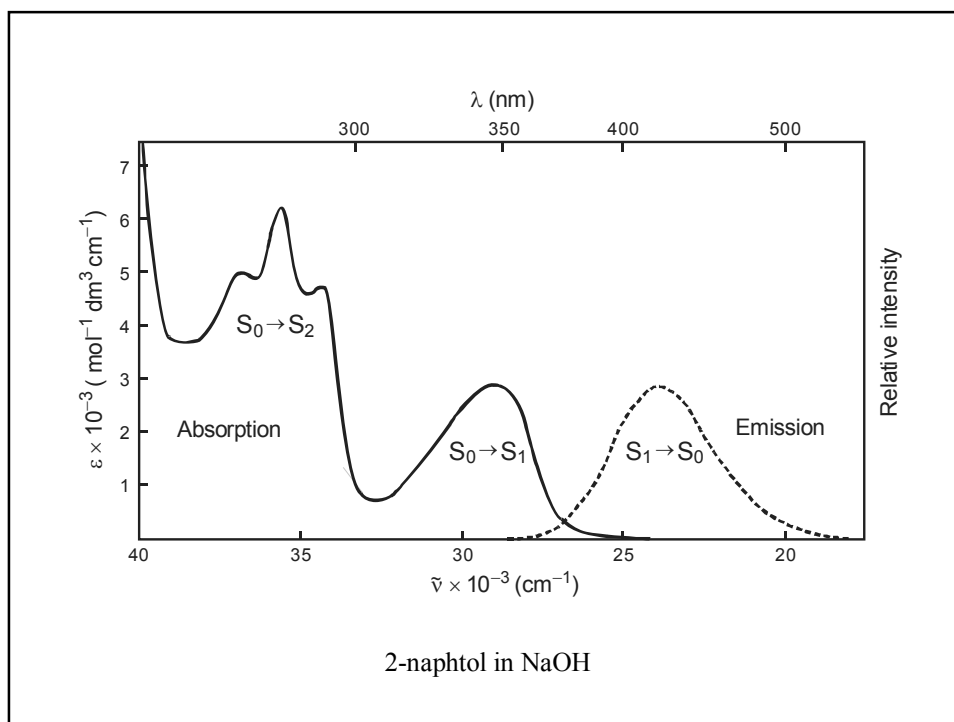

Tabela 3. pK_a values in the ground and lowest excited S₁ and T₁ states for organic compounds

Compound	pK _a (S ₀)	pK _a [*] (S ₁)	pK _a [*] (T ₁)
1-Naphtol	9.2	2,0	–
2-Naphtol	9.5	2,8–3,1	7,7–8,1
1-Naphtoic acid	3.7	10–12	3,8–4,6
Acridine cation	5.5	10,6	5,6
2-Naphtylamine cation	4.1	–2	3,1–3,3